

ALIA

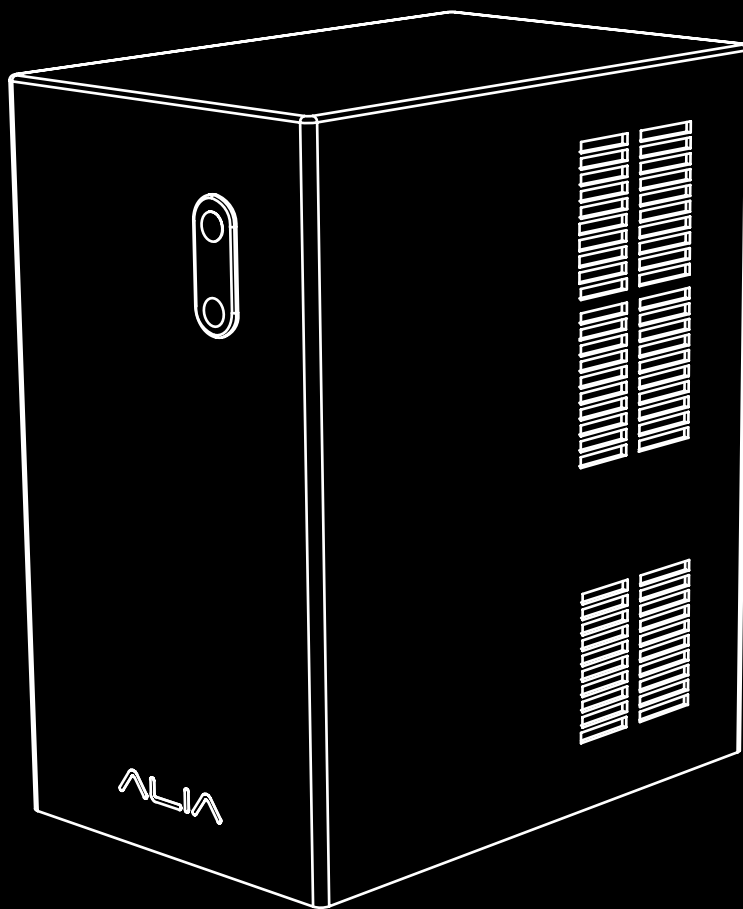

CHILLED STREAM INSTALLATION MANUAL

CAUTION

Congratulations on your purchase of ALIA Chilled Stream. This product is designed to deliver instant filtered chilled water. Before using the Chilled Stream, please read the instructions carefully for safety and best use.

WARNINGS

- If the machine has been placed on its side or turned upside down, wait for at least 8 hours before putting it into operation.
- Before carrying out any maintenance or cleaning operation, remove the plug from the main socket.
- Failure to comply with any of these safety regulations could cause fires, electric shocks or damage the machine.
- Keep ventilation openings, in the appliance enclosure or in the built-in structure, clear of obstruction.
- Do not use mechanical devices or other means to accelerate the defrosting process, other than those recommended by the manufacturer.
- Do not damage the refrigerant circuit.
- When positioning the appliance, ensure the supply cord is not trapped or damaged.
- Do not locate multiple portable socket-outlets or portable power supplies at the rear of the appliance.

PLACE OF INSTALLATION

- Do not place the machine near flammable solvents such as alcohol or diluents.
- Avoid installing the machine in excessively damp or dusty areas, places exposed to direct sunlight, outdoors, or near heat sources. Installing the machine in these environments can cause fires or electric shocks.
- Ensure there is about 20 cm of free space around the machine to allow for proper air circulation. Special ventilation grills should be prepared to facilitate the disposal of heat produced by the refrigerating circuit. If no special ventilation grille is available, keep the cabinet door open for ventilation.

CONNECTIONS

- Do not connect or disconnect the machine from the socket with wet hands.
- Keep the cable away from the radiator of the machine.
- Do not connect the machine to a socket that is also powering other equipment (e.g., extensions, 2 or 3 plug adaptors).

- Do not use the machine if the power cable is tied or knotted.

- Use the new hose sets supplied with the appliance. Do not reuse old hose sets.

REMINDERS

- This appliance can be used by children aged 8 years and above and by persons with reduced physical, sensory, or mental capabilities, or lack of experience and knowledge, if they have been given supervision or instruction on how to use the appliance safely and understand the hazards involved.

- Children should not play with the appliance.

- Cleaning and user maintenance should not be performed by children without supervision.

CHILLED STREAM LAYOUT

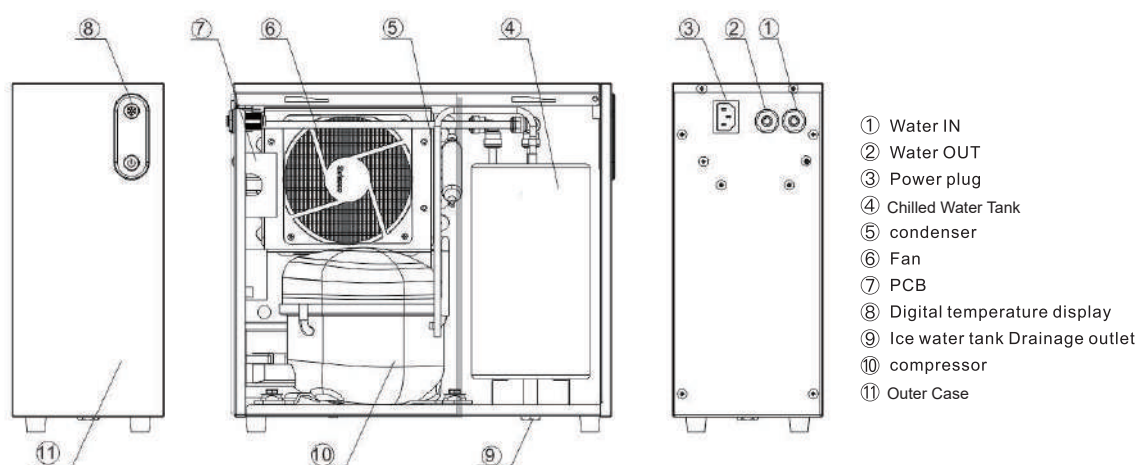

SPECIFICATION LIST

Outcase	Metal
Dimension(mm)	D350 x W140 x H310mm
G.W	11.5kgs
N.W	10kgs
packing size	D420*W200*H385mm
Function	chilled water
Heat dissipation mode	air-cooled
Voltage	220V-240V/50Hz
Power	130W/0.8A
Temperature set range	4-11°C
Chilled water/h	2.5-3L(3°C-12°C)
Water inlet pressure	150 - 300 kPa
Inlet water temperature	10-38°C
Surrounding temperature	10-43°C
Noise	<45db
Refrigerant	R600a
Refrigerant weight	30g
Chilled water tank capacity	2L

QUICK CONNECTION TUBE GUIDE

The tubing for the chiller uses a quick connect locking mechanism to lock the tubes in place. Be careful not to damage your tubing as you unpack it. And make sure to remove any plugs before insert tubing.

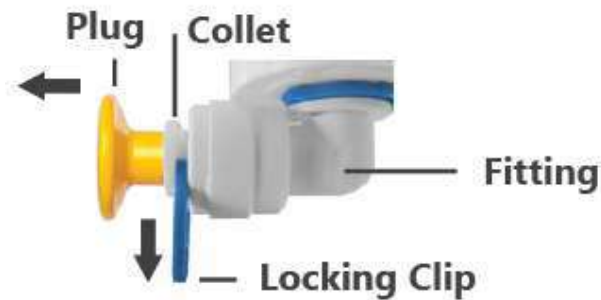

RELEASE TUBING/PLUGS

If there is a Locking Clip on the Collect. It must be removed before the tubing can be released. Push and hold the Collet in to release the lock while pulling out on the Tube/Plugs.



NOTE! Collet must be held down while pulling up on the tube to release the tube.

INSERT OR REMOVE LOCKING CLIPS

To lock a Tube in place make sure the Tubing is fully inserted. The Clip must be removed before the Tubing can be removed. To remove the Clip-pull away until it slides out from between the Collet and Fitting.

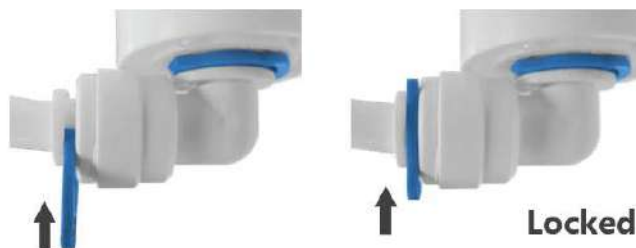

TO CUT TUBING

NOTE!

Improperly cut Tubing may leak water or fail to lock into Fittings. Wait until all elements of your filter System are in their final locations before cutting your Tubing. Make sure you measure the length you will need before cutting.

INSTALLATION

This describes how to connect the Chiller System to a Water Filter System that uses 1/4" quick connect tubing. If you have 3/8" or other connection needs you will need to purchase additional adapters and fittings.



1. Remove the blue locking clip and protective cover from the Water Inlet and the Water Outlet.



2. Insert the PE tube into the water inlet and the other end of tube to connect the filter.



3. Insert the PE tube into the water outlet and the end of tube to connect to the chilled water hose



4. Insert the PE tube into one side of the ball valve and lock the blue clip.

5. Connect the Water In side tube to the filter side, Water Out side tube to the faucet side.

6. Check that all tubes are fully inserted and secure, open the stop tap, then make sure there are no leakage.



7. Plug the power



8. Turn on the chiller

NOTE! Check to make sure all tubes are fully inserted and secure.

SYSTEM STARTUP

1. Turn on your water flow and wait for water to come through Carefully check your System for leaks.
 - Feel and visually inspect every connection point for leaks. If a leak occurs turn the water flow off.
 - Then secure the leaking connection point before turning water to the system on again, and rechecking.
2. Once you're sure there are no leaks let your water run for 5 minutes to flush the water chiller, do not drink the water until the chiller has been flushed

You're now ready to enjoy fresh cold water!

ADJUSTING CHILLER TEMPERATURE

Temperature should not be adjusted while the chiller is operating, to prevent accidental damage, the temperature adjustment knob is protected by the faceplate.

INSTRUCTIONS FOR USE

Initial Check: Ensure the machine is standing flat. After powering on, check if the compressor is running. Within 15 minutes, the water temperature inside the machine should noticeably drop.

Temperature Range: The normal operating temperature range is as follows: when the water temperature reaches 4°C, the compressor will automatically shut off. When the water temperature rises to 7°C, the compressor will automatically turn on.

Power Supply: Use a 220V-240V, 50Hz single-phase AC power supply. The chiller should be connected to a dedicated power outlet, with a 10A fuse installed in the power line. In areas with high humidity, ensure the use of a grounding wire and install a leakage protection switch.

Power Cord: Do not replace the power cord arbitrarily to prevent high temperatures from causing failure and leakage dangers. If the power cord is damaged, it should be replaced by professional maintenance personnel using appropriate tools. Avoid placing the power cord under pressure or squeezing it with other objects to prevent damage and accidental safety hazards.

First : before the initial use, fill the water into the ice water tank till the water flows out from the tap outlet, then turn on the machine

Water and Environmental Specifications: The inlet water pressure should be between 150kPa -300kPa, with an inlet water temperature of 10-30°C. The ambient humidity should be less than 60% ±10%.

Warning: The plug must match the socket with the ground wire. Sockets should be properly connected as shown (E Earth, N Neutral, L Live)

PRODUCT HANDLING AND PLACEMENT

Handling Abnormalities: If you experience numbness in your hand, hear abnormal sounds, or notice unusual smells or smoke, immediately cut off the power supply, stop using the chiller, and contact the company's after-sales department.

Water and Heavy Object Precautions: Keep the chiller away from water. Do not place containers of water on top of the chiller, as leaks can compromise insulation and lead to electric shocks or fires. Additionally, do not place heavy objects or debris on top of the chiller to prevent damage.

Maintenance and Safety: Do not attempt to disassemble, repair, or modify the chiller without proper authorization. After a power failure, unplug the chiller and wait at least 5 minutes before reconnecting it to the power supply. By following these guidelines, you can ensure the safe and efficient operation of your chiller.

CHILLER OPERATION



1. Temperature adjustable range:4~11 °C.



Model : AG-CS101



Model : AG-CS102

To adjust chilled water temperature hold Snowflake icon  for 5 seconds. Keep pressing the snowflake icon  to cycle through the temperature range. Press the power button  one time to confirm the desired temperature.

► Troubleshooting

If you find abnormal conditions during use, please stop using it. Unplug the power cord and check the following:

Fault phenomenon	Check
No response to power on	Confirm if the cable is well connected.
	b. Please check with professional installers after making sure the cable is well connected.
Slow cooling speed	a. If the machine is in the sunny environment, please move the machine to the shade.
Display E1	Open the outcase to check if the temperature control probe cable for chilled water is firmly inserted.